

LOW VOLTAGE AC DRIVES

ABB machinery drives

ACS380, 0.25 to 22 kW/0.37 to 30 hp



**Persistent
and adaptable
performance.
ACS380 machinery drives.**

Table of contents

004	The ACS380 machinery drives
006	Adaptability, reliability and persistence for machine building
008	ACS380 drives software with versatile features
009	Technical data
010	How to select a drive
011	Ordering information ACS380
012	Ratings, types and voltages
013	Dimensions
013	Ordering variants
014	Drive commissioning and adaptable use with your control panel
015	Tools for configuration, monitoring and process tuning
016	Flexible connectivity to automation networks
017	Standard software with versatile features
018	Input/output, extension and feedback modules for increased connectivity
019	Brake options
020	EMC – electromagnetic compatibility
021	Input chokes and dU/dt filters
022	Cooling, fuses and circuit breakers
024	Need a motor? This is our offering.
025	Save time, ease troubleshooting and improve drive performance with ABB smartphone apps
026	Services to match your needs
027	Drives service
028	Notes

The ACS380 machinery drives

Persistent and adaptable performance

The ACS380 is an all-compatible machinery drive ideal for machine building thanks to its robust and compact design. The all-compatible ABB drives share the same architecture and user interfaces for easy usability.

Easy to adapt and configure to machines

With ACS380, commissioning is quick and easy thanks to its intuitive control panel. Also, connecting to automation systems is easy thanks to preconfigured fieldbus protocols. On the hardware side, ease of use has been enhanced by having all the essential features built-in as standard. This reduces the need for additional hardware and simplifies drive selection.

Persistent performance for your application

The ACS380 machinery drive is a robust and compact drive ideal for machine building. It is ready-customized and comes in a power range from 0.25 to 22 kW, and voltages from 200 to 240 V (one-phase) and 380 to 480 V (three-phase). ACS380 offers EMC and connectivity variants with built-in EMC filters and/or preconfigured fieldbus protocols for ease of integration and connectivity. This saves a lot of time and money for machine builders using large numbers of drives per year.

Reliability and consistent high quality

The ACS380 drives have improved durability and reliability in harsh conditions, including coated circuit boards and enclosure IP20 as standard. All drives are tested during production at maximum temperatures with nominal loads. Tests cover both performance and all protective functions. The drives are designed for an ambient temperature of up to 50°C without derating. The drives have in their class a unique 3-phase measurement that gives very reliable earth fault protection. Also, the foil coated control panel offers a good protection against dust and gases and the galvanically isolated fieldbus gives good noise immunity.

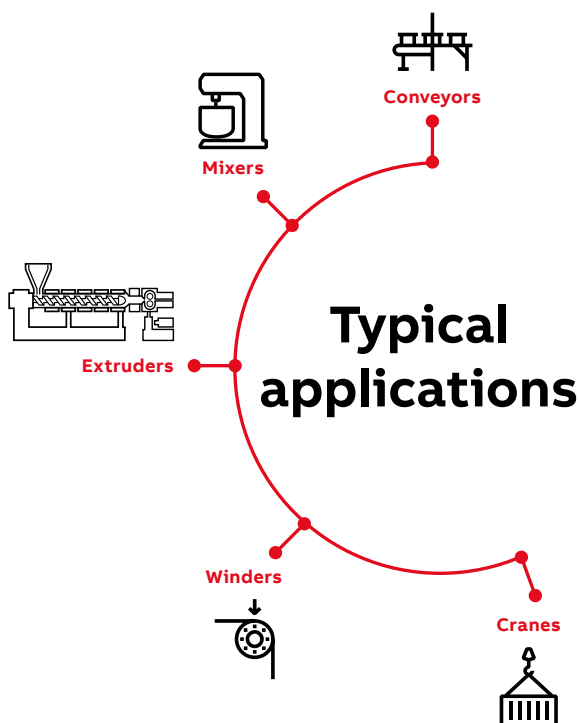



Adaptability, reliability and persistence for machine building

The ACS380 machinery drives are part of ABB's all-compatible drives portfolio. The drives give you persistent performance throughout their whole life cycle. They also offer a wider range of standard and optional features for optimal machine building.



Ease of use built-in

ACS380 has as standard control panel with clear display. The control panel's icon-based menu helps you set up the drive quickly and effectively without needing to study manuals. If there is need for an alphanumeric, multilingual graphical user panel, also that is available.



All-compatible user interface making your life easier

ACS380 is part of ABB all-compatible drives portfolio. Other product in this portfolio are ACS480, ACS580 and ACS880 drives. All these drives have the same, easy to use PC tools and similar intuitive multilingual user interface as well as parameter structure, making using and learning them fast and easy.

Simple to select and install

Built-in features such as an EMC filter, a Modbus RTU fieldbus interface and safe torque off functionality simplify drive selection, installation and use. DriveSize helps to select the optimal drive and motor for the application.



Easy setup and integration to automation

ACS380 can be easily set-up by using the control panel or easy to use PC tools. Settings can also be copied to several drives by using either assistant control panel or PC tools. Also download the settings to an unpowered drive is possible by using the cold configuration tool. Preconfigured fieldbus protocols enable connectivity with all major industrial automation networks with minimized effort and complexity.





Designed for maximum reliability

Design features like coated control boards, minimized air flow through the control board section, reliable earth fault protection by 3-phase current measurement and design for 50°C ambient temperature make ACS380 a safe choice for customers expecting high reliability. This is topped up by full load test that is done to every single drive during the production.



Drive based programmability

ACS380 has built-in as standard possibility for adaptive programming that enables customizing the drive software by using either sequential or block programming. This can in some cases even eliminate the need of a separate PLC.



Remote monitoring

With a built-in web server and standalone data logger, NETA-21 remote monitoring tool kit enables worldwide and secure remote access to drive.



Same startup and maintenance tools as for other ABB automation products

ACS380 is using the same tools as other ABB all-compatible drives. Drive composer PC tool for startup, configuration, monitoring and process tuning. Automation Builder for automation engineering and Drive Manager for single point of commissioning.

ACS380 drives software with versatile features

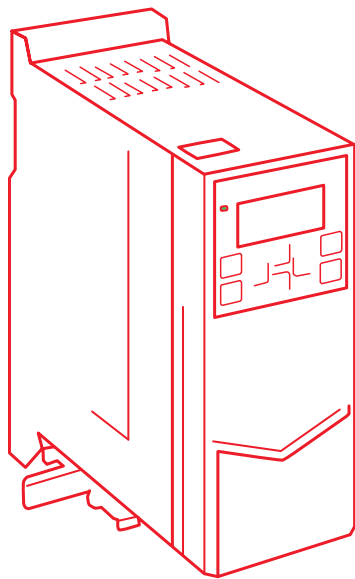

Exceptional motor control performance. Whether the requirement is high starting torque, accurate speed control, stable torque or tolerance for sudden load variations, ACS380 can do it with or without encoder feedback. ACS380 can be used even in simple positioning applications when using external motion controller.

One drive for different motor types. ACS380 supports perfectly both induction and permanent magnet motors.

Silent motor operation. Noise can be further reduced by the energy optimizer or by increasing the drive switching frequency.

"Mini PLC" inside the drive. Scale up and customize the drive to your application's requirements with adaptive programming.

Easy integration to automation. Preconfigured fieldbus protocols enable connectivity with all major industrial automation networks with minimized effort and complexity.

Built-in support for limit switches

Integrated mechanical brake control

Additional machinery features like fast stop functions and parabolic speed reference

Analyze and optimize the process with the load profile log, which shows you how the drive has been used.

Technical data

Mains connection	
Voltage and power range	1-phase, 200 to 240 V, +10%/-15% 0.25 to 2.2 kW 3-phase, 380 to 480 V, +10%/-15% 0.25 to 22 kW
Frequency	50/60 Hz \pm 5%
Common DC connection	
DC voltage level	-1 types 270 to 325 V \pm 10% -4 types 485 to 620 V \pm 10%
Charging circuit	Internal charging circuit
Motor connection	
Voltage	0 to U_N , 3-phase
Frequency	0 to 599 Hz
Motor control	Scalar control Vector control
Switching frequency	1 to 12 kHz, default 4 kHz
Dynamic braking	Flux braking (moderate or full) Resistor braking (optional)
Motor control performance	
Speed control performance, open loop	
Static accuracy	20% of motor rated slip
Dynamic accuracy	1% _s with 100% torque step
Speed control performance, closed loop	
Static accuracy	0.1% of motor rated speed
Dynamic accuracy	<1% _s with 100% torque step
Torque control performance	
Torque step rise time	< 10 ms, rated torque step
Non-linearity	\pm 5% with rated torque
Braking power connection	
Brake chopper	Built-in brake chopper as standard
Brake resistor	External resistor connected to drive
Functional safety	
Built-in safety features	Safe torque off (STO) acc. to EN/IEC61800-5-2: IEC61508 ed2: SIL 3, IEC 61511: SIL 3, IEC 62061: SIL CL 3, EN ISO 13849-1: PL e
Environmental limits	
Ambient temperature	
Transportation and storage	-40 to +70 °C (-40 to +158 °F)
Operation	-10 to +50 °C (14 to 122 °F), with derating up to 60 °C (except R0, which has max temperature of 50 °C)
Cooling method	Air-cooled, dry clean air
Altitude	0 to 4000 m, (0 to 13000 ft) for 400 V units (see allowed power systems in HW manual) 0 to 2000 m, (0 to 6600 ft) for 200 V units derating above 1000 m (3300 ft)
Relative humidity	5 to 95%, no condensation allowed
Degree of protection	IP20 as standard
Contamination levels	No conductive dust allowed
Storage	IEC 60721-3-1, Class 1C2 (chemical gases) Class 1S2 (solid particles)
Transportation	IEC 60721-3-2, Class 2C2 (chemical gases) Class 2S2 (solid particles)
Operation	IEC 60721-3-3, Class 3C2 (chemical gases) Class 3S2 (solid particles)
Product compliance	
CE	
Low Voltage Directive 2006/95/EC, EN 61800-5-1: 2007	
Machinery Directive 2006/42/EC, EN 61800-5-2: 2007	
EMC Directive 2004/108/EC, EN 61800-3: 2004 + A1: 2012	
UL, cUL certification	
TUV Certification for functional safety	
Quality assurance system ISO 9001	
Environmental system ISO 14001	
Waste electrical and electronic equipment directive (WEEE) 2002/96/EC	
RoHS directive 2011/65/EU	
EAC	

How to select a drive

It is very easy to select the right drive. This is how you build up your own ordering code using the type designation key.

Start with identifying your supply voltage. This tells you what rating table to use. See page 12.

Select the ordering code for the ACS380 machinery drive by choosing either the standard or the configured variant (page 11). Then choose the desired EMC level on page 11. If the configured variant is selected, choose your fieldbus protocol (page 16) by selecting the correct option code and add the option codes to drive's ordering code.

Ordering information ACS380
How to built up your ordering code

The type designation tells you the specifications and configuration of the drive. The table shows the primary drive variants.

Sample type code: ACS380-04AC-0400-4 (V1) (V1) (Medium) (Medium) (not possible to add options as plus code)

Sample type code: ACS380-04AC-0246-4 (K15) (L35) (configured variant, possible to add options as plus code)

Segment	A	B	C	D	E	F
ACS380	04	02	04	00	4	

Product series
Types and construction
Rating
Voltage
Option code

Segment	Option	Description
A	04	04 V 180/208 V range or 04 V 208/230 V range
B	02	02 V 230/240 V range or 02 V 230/240 V range
C	04	04 V 180/208 V range or 04 V 208/230 V range
D	00	00 V 180/208 V range or 00 V 208/230 V range
E	04	04 V 180/208 V range or 04 V 208/230 V range
F	4	4 V 180/208 V range or 4 V 208/230 V range

Option codes for configured variant

Segment	Option	Description
F	4K15	4K15-01: Decoupled protocol
F	4K16	4K16-01: Profibus protocol
F	4K17	4K17-01: Profibus protocol
F	4K18	4K18-01: Profibus protocol
F	4K19	4K19-01: Profibus protocol
F	4K20	4K20-01: Profibus protocol
F	4K21	4K21-01: Profibus protocol
F	4K22	4K22-01: Profibus protocol
F	4K23	4K23-01: Profibus protocol
F	4K24	4K24-01: Profibus protocol
F	4K25	4K25-01: Profibus protocol
F	4K26	4K26-01: Profibus protocol
F	4K27	4K27-01: Profibus protocol
F	4K28	4K28-01: Profibus protocol
F	4K29	4K29-01: Profibus protocol
F	4K30	4K30-01: Profibus protocol
F	4K31	4K31-01: Profibus protocol
F	4K32	4K32-01: Profibus protocol
F	4K33	4K33-01: Profibus protocol
F	4K34	4K34-01: Profibus protocol
F	4K35	4K35-01: Profibus protocol
F	4K36	4K36-01: Profibus protocol
F	4K37	4K37-01: Profibus protocol
F	4K38	4K38-01: Profibus protocol
F	4K39	4K39-01: Profibus protocol
F	4K40	4K40-01: Profibus protocol
F	4K41	4K41-01: Profibus protocol
F	4K42	4K42-01: Profibus protocol
F	4K43	4K43-01: Profibus protocol
F	4K44	4K44-01: Profibus protocol
F	4K45	4K45-01: Profibus protocol
F	4K46	4K46-01: Profibus protocol
F	4K47	4K47-01: Profibus protocol
F	4K48	4K48-01: Profibus protocol
F	4K49	4K49-01: Profibus protocol
F	4K50	4K50-01: Profibus protocol
F	4K51	4K51-01: Profibus protocol
F	4K52	4K52-01: Profibus protocol
F	4K53	4K53-01: Profibus protocol
F	4K54	4K54-01: Profibus protocol
F	4K55	4K55-01: Profibus protocol
F	4K56	4K56-01: Profibus protocol
F	4K57	4K57-01: Profibus protocol
F	4K58	4K58-01: Profibus protocol
F	4K59	4K59-01: Profibus protocol
F	4K60	4K60-01: Profibus protocol
F	4K61	4K61-01: Profibus protocol
F	4K62	4K62-01: Profibus protocol
F	4K63	4K63-01: Profibus protocol
F	4K64	4K64-01: Profibus protocol
F	4K65	4K65-01: Profibus protocol
F	4K66	4K66-01: Profibus protocol
F	4K67	4K67-01: Profibus protocol
F	4K68	4K68-01: Profibus protocol
F	4K69	4K69-01: Profibus protocol
F	4K70	4K70-01: Profibus protocol
F	4K71	4K71-01: Profibus protocol
F	4K72	4K72-01: Profibus protocol
F	4K73	4K73-01: Profibus protocol
F	4K74	4K74-01: Profibus protocol
F	4K75	4K75-01: Profibus protocol
F	4K76	4K76-01: Profibus protocol
F	4K77	4K77-01: Profibus protocol
F	4K78	4K78-01: Profibus protocol
F	4K79	4K79-01: Profibus protocol
F	4K80	4K80-01: Profibus protocol
F	4K81	4K81-01: Profibus protocol
F	4K82	4K82-01: Profibus protocol
F	4K83	4K83-01: Profibus protocol
F	4K84	4K84-01: Profibus protocol
F	4K85	4K85-01: Profibus protocol
F	4K86	4K86-01: Profibus protocol
F	4K87	4K87-01: Profibus protocol
F	4K88	4K88-01: Profibus protocol
F	4K89	4K89-01: Profibus protocol
F	4K90	4K90-01: Profibus protocol
F	4K91	4K91-01: Profibus protocol
F	4K92	4K92-01: Profibus protocol
F	4K93	4K93-01: Profibus protocol
F	4K94	4K94-01: Profibus protocol
F	4K95	4K95-01: Profibus protocol
F	4K96	4K96-01: Profibus protocol
F	4K97	4K97-01: Profibus protocol
F	4K98	4K98-01: Profibus protocol
F	4K99	4K99-01: Profibus protocol
F	4K00	4K00-01: Profibus protocol

*Not configured 4K60, 4K61, 4K62, 4K63, 4K64, 4K65, 4K66, 4K67, 4K68, 4K69, 4K70, 4K71, 4K72, 4K73, 4K74, 4K75, 4K76, 4K77, 4K78, 4K79, 4K80, 4K81, 4K82, 4K83, 4K84, 4K85, 4K86, 4K87, 4K88, 4K89, 4K90, 4K91, 4K92, 4K93, 4K94, 4K95, 4K96, 4K97, 4K98, 4K99, 4K00.

Page 11

Choose other options (on page 18) and add the option codes to the drive's order code. Remember to use a "+" mark before each option code.

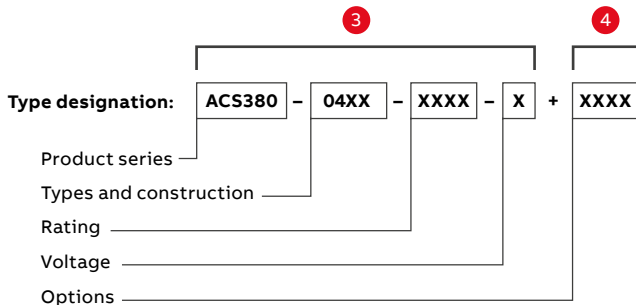

- 1
- 2
- 3
- 4

Choose your motor's power and current rating from the ratings table on page 12.

ACS380

UL, 200 V range (200 to 480 V). The power ratings are valid at nominal voltage 200 V (208 to 230 V).

Heavy-duty use	Current		Light overload use		Nominal ratings		Type designation	Frame size
	I _{FL}	I _{FL}	I _{FL}	I _{FL}	P _N	V _N		
0.37	1.0	1.0	0.37	0.37	0.37	2.4	ACS380-04A-0241-1	80
0.55	1.5	1.5	0.55	0.55	0.55	3.7	ACS380-04A-0241-2	90
0.75	2.0	2.0	0.75	0.75	0.75	5.5	ACS380-04A-0241-3	100
1.1	2.8	2.8	1.1	1.1	1.1	7.5	ACS380-04A-0241-4	112
1.5	3.8	3.8	1.5	1.5	1.5	11.0	ACS380-04A-0241-5	132
2.2	5.2	5.2	2.2	2.2	2.2	15.0	ACS380-04A-0241-6	160
3.0	7.0	7.0	3.0	3.0	3.0	20.0	ACS380-04A-0241-7	180

UL, 230 V range (230 to 480 V). The power ratings are valid at nominal voltage 230 V (208 to 230 V).

Heavy-duty use	Current		Light overload use		Nominal ratings		Type designation	Frame size
	I _{FL}	I _{FL}	I _{FL}	I _{FL}	P _N	V _N		
0.37	1.0	1.0	0.37	0.37	0.37	2.4	ACS380-04A-0242-1	80
0.55	1.5	1.5	0.55	0.55	0.55	3.7	ACS380-04A-0242-2	90
0.75	2.0	2.0	0.75	0.75	0.75	5.5	ACS380-04A-0242-3	100
1.1	2.8	2.8	1.1	1.1	1.1	7.5	ACS380-04A-0242-4	112
1.5	3.8	3.8	1.5	1.5	1.5	11.0	ACS380-04A-0242-5	132
2.2	5.2	5.2	2.2	2.2	2.2	15.0	ACS380-04A-0242-6	160
3.0	7.0	7.0	3.0	3.0	3.0	20.0	ACS380-04A-0242-7	180

Motor ratings
I_{FL} = Rated current, continuous, without overloading at 50 °C.
I_{FL} = Typical motor power in to be used.

Maximum output torque
T_{FL} = Maximum output torque, available for 2 minutes at 50 °C, then cooling is allowed by drive manufacturer.

Heavy-duty use
I_{FL} = Continuous current allowing 100% V_N for 1 minute every 10 minutes at 50 °C.
I_{FL} = Typical motor power in heavy-duty use.

Light overload use
I_{FL} = Continuous current allowing 110% V_N for 1 minute every 10 minutes at 50 °C.
I_{FL} = Typical motor power in light overload use.

The ratings apply at 50 °C ambient temperature. For further information, see the user's manual, document code: ACS380-000002014.

Page 12

Input/output, extension and feedback modules for increased connectivity

Standard input and output of ACS380 machinery drive can be extended by using optional input/output extension modules. The modules are easily installed in the extension slots located in the drive. It is also possible to use an optional speed feedback module that supports TTL and HTL pulse encoder.

Extension module options	Description	Type designation
Option code	External I/O	EXT-IO
+L310	External relay option (Relay)	REL-01
+L311	External relay option (Relay)	REL-01
+L312	IO extension	IO-01
+L313	IO extension	IO-01

Feedback interface module options	Connections	Option
Option code	Encoder interface - External I/O	EXT-IO
+L310	Encoder interface - External I/O	EXT-IO

Page 18

Ordering information ACS380

How to built up your ordering code

The type designation tells you the specifications and configuration of the drive.

The table shows the primary drive variants.

Sample type code 1: ACS380-042S-02A6-4 (I/O & Modbus variant, not possible to add options as pluscode)

Sample type code 2: ACS380-042C-02A6-4+K475+ L535 (Configured variant, possible to add options as pluscode)

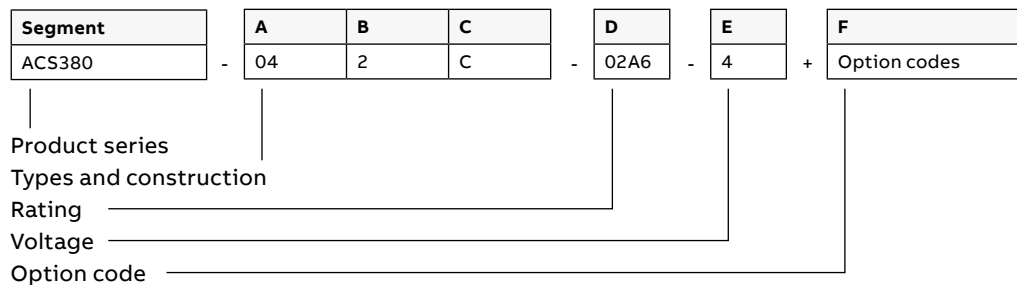

Basic codes		
Segment	Option	Description
A	Construction	04 = Module, IP20
B	EMC filter	0 = C3 (400 V variant) or C4 (200 V Variant), 2 = High filtering level for First environment (EN 61800-3, Class C2)
C	Connectivity	S = Standard variant (I/O and Modbus), C = Configured variant
D	Current rating	For example, 02A6 refers to a nominal output current of 2.6 A
E	Voltage rating	1 = 1-phase 230 V, 4 = 3-phase 380...480 V

Option codes for configured variant (ACS380-04x)					
Segment	Option	Code	Description		
F	Fieldbus	+K451	FDNA-01 DeviceNet protocol		
		+K454	FPBA-01 preconfigured Profibus-DP protocol		
		+K457	FCAN-01 preconfigured CANopen protocol		
		+K469	FECA-01 preconfigured EtherCAT protocol		
		+K470	FEPL-02 Ethernet POWERLINK protocol		
		+K475	FENA-21 preconfigured Profinet protocol (Ethernet/IP or Modbus/TCP built-in)		
		+K490*	FEIP-21 Preconfigured EtherNet/IP protocol		
		+K491*	FMBT-21 Prenconfigured Modbus/TCP protocol		
		+K492*	FPNO-21 Preconfigured PROFINET IO protocol		
		+K495	BCAN-11 Preconfigured CANopen interface		
		I/O		+L511	BREL-01 External relay option (4x relay) (side option)'
				+L534	BAPO-01 External 24 V DC (side option)
				+L535	BTAC-02 HTL/TTL encoder interface + External 24 V DC (side option)
				+L538	BMIO-01 I/O & Modbus extension module (front option)
+L515	BIO-01 I/O extension module (front option,can be used together with fieldbus)				
Languages: The product package includes the User interface guide and Quick installation and start-up guide in English, French, German, Italian and Spanish, and in the local language (if it is available). The option code determines the language variants of the Hardware manual and Firmware manual.		+R700	English		
		+R701	German		
		+R702	Italian		
		+R703	Dutch		
		+R704	Danish		
		+R705	Swedish		
		+R706	Finnish		
		+R707	French		
		+R708	Spanish		
		+R709	Portuguese (in Portugal) Russian		
		+R711	Russian		
		+R712	Chinese		
		+R714	Turkish		

*Preconfigured K490, K491, K492 coming during 2018. In the meantime functionality can be done using K475.

Ratings, types and voltages

ACS380

$U_N = 200$ V (range 200 to 240 V). The power ratings are valid at nominal voltage 200 V (0.25 to 3.0 kW)

Heavy-duty use		Maximum output current		Light-overload use		Nominal ratings		Type designation	Frame size
P_{Hd} kW	I_{Hd} A	I_{max} A	P_{Ld} kW	IL_d A	P_N kW	I_N A			
0.25	1.8	3.2	0.37	2.3	0.37	2.4	ACS380-04xx-02A4-1	R0	
0.37	2.4	4.3	0.55	3.5	0.55	3.7	ACS380-04xx-03A7-1	R0	
0.55	3.7	6.7	0.75	4.6	0.75	4.8	ACS380-04xx-04A8-1	R1	
0.75	4.8	8.6	1.1	6.6	1.1	6.9	ACS380-04xx-06A9-1	R1	
1.1	6.9	12.4	1.5	7.4	1.5	7.8	ACS380-04xx-07A8-1	R1	
1.5	7.8	14.0	2.2	9.3	2.2	9.8	ACS380-04xx-09A8-1	R2	
2.2	9.8	17.6	3.0	11.6	3.0	12.2	ACS380-04xx-12A2-1	R2	

$U_N = 400$ V (range 380 to 480 V). The power ratings are valid at nominal voltage 400 V (0.37 to 22 kW)

Heavy-duty use		Maximum output current		Light-overload use		Nominal ratings		Type designation	Frame size
P_{Hd} kW	I_{Hd} A	I_{max} A	P_{Ld} kW	IL_d A	P_N kW	I_N A			
0.37	1.2	2.2	0.55	1.7	0.55	1.8	ACS380-04xx-01A8-4	R0	
0.55	1.8	3.2	0.75	2.5	0.75	2.6	ACS380-04xx-02A6-4	R1	
0.75	2.6	4.7	1.1	3.1	1.1	3.3	ACS380-04xx-03A3-4	R1	
1.1	3.3	5.9	1.5	3.8	1.5	4	ACS380-04xx-04A0-4	R1	
1.5	4	7.2	2.2	5.3	2.2	5.6	ACS380-04xx-05A6-4	R1	
2.2	5.6	10.1	3	6.8	3	7.2	ACS380-04xx-07A2-4	R1	
3	7.2	13	4	8.9	4	9.4	ACS380-04xx-09A4-4	R1	
4	9.4	16.9	5.5	12	5.5	12.6	ACS380-04xx-12A6-4	R2	
5.5	12.6	22.7	7.5	16.2	7.5	17	ACS380-04xx-17A0-4	R3	
7.5	17	30.6	11	23.8	11	25	ACS380-04xx-25A0-4	R3	
11	25	44	15	31	15	32	ACS380-04xx-032A-4	R4	
15	32	57	18.5	36	18.5	38	ACS380-04xx-038A-4	R4	
18.5	38	68	22	43	22	45	ACS380-04xx-045A-4	R4	
22	45	81	22	48	22	50	ACS380-04xx-050A-4	R4	

Nominal ratings

I_N Rated current available continuously without overloadability at 50 °C.

P_N Typical motor power in no-overload use.

Maximum output current

I_{max} Maximum output current. Available for 2 seconds at start, then as long as allowed by drive temperature.

Heavy-duty use

I_{Hd} Continuous current allowing 150% I_{Hd} for 1 minute every 10 minutes at 50 °C.

P_{Hd} Typical motor power in heavy-duty use.

Light-overload use

I_{Ld} Continuous current allowing 110% I_{Ld} for 1 minute every 10 minutes at 50 °C.

P_{Ld} Typical motor power in light-overload use.

The ratings apply at 50 °C ambient temperatures.

For derating at higher altitudes, temperatures or switching frequencies, see the user's HW manual, document code: 3AXD50000029274

Dimensions

ACS380 IP20				
Frames	Height mm	Width mm	Depth mm	Weight kg
R0	223	70	174	1.4
R1	223	70	174	1.6
R2	223	95	174	1.9
R3	223	169	174	3.0
R4	223	260	174	5.8



Drive commissioning and adaptable use with your control panel

ACS380 has as standard an icon based control panel with clear display. If there is need for other type of panel or mounting the panel in the door of the enclosure, also that is possible.



Control panel as standard

Almost anyone can set up and commission the machinery drive using available control panels. The ACS380 comes with the integrated icon based control panel as standard. You do not need to know any drive parameters as the control panel helps you to set up the essential settings quickly and get the drive into action. In addition, ACS380 supports the assistant control panel (AP-I, AP-S or AP-W).



Assistant control panel, ACS-AP-I*

The optional Assistant control has a graphical, multilingual display. There is no need to know any drive parameters, as the control panel helps you set up the essential settings quickly and get the drive into action without a hassle. Panel can be used with any products belonging to ABB all-compatible product portfolio.



Bluetooth control panel, ACS-AP-W*

The optional Bluetooth panel enables connection with the Drivetune mobile app. The app is available for free from Google Play and the Apple App store. Together with the Drivetune app and the Bluetooth panel, users can, for example, commission and monitor the drive remotely.



Basic control panel, ACS-BP-S

If there is a need to install basic panel into cabinet door, ACS-BP-S is right choice. The icon based control panel supports users with basic operation, settings and fault tracking when nothing extra is needed.



Control panel mounting platform, DPMP-01

This mounting platform is for flush mountings. The panel mounting platform does not include the control panel.



Control panel mounting platform, DPMP-02

This mounting platform is for surface mounting. The panel mounting platform does not include the control panel.

* Also compatible with other ABB all-compatible drives: ACS480, ACS580, and ACS880 drives.

Control panel options		
Ordering code	Description	Type designation
3AUA0000088311	Assistant control panel	ACS-AP-I
3AUA0000064884	Assistant control panel	ACS-AP-S
3AXD0000025965	Assistant control panel with bluetooth interface	ACS-AP-W
3AXD0000028828	Basic control panel	ACS-BP-S
3AUA0000108878	Control panel mounting platform (flush mounted)	DPMP-01
3AXD0000009374	Control panel mounting platform (surface mounted)	DPMP-02

Tools for configuration, monitoring and process tuning

ACS380 has various tools simplifying the commissioning, operation and monitoring of the drive.



Easy configuration for unpowered drives

With CCA-01 tool it is possible to configure drive parameters and even download a new software from PC to the unpowered ACS380. The power supply is taken from a PC USB port.



PC tools

The Drive composer PC tool offers fast and harmonized setup, commissioning and monitoring. The free version of the tool provides startup and maintenance capabilities and gathers all drive information, such as parameter loggers, faults, and backups into a support diagnostics file. Drive composer pro provides additional features such as custom parameter windows, graphical control diagrams of the drive's configuration, and improved monitoring and diagnostics.

Using the BCBL-01 cable, the PC can be connected directly to the RJ-45 panel port on the top of the ACS380 drive.

When using the Assistant control panel, the Drive composer tool is connected to the drive using the mini USB connection on the panel.



Remote monitoring

With a built-in web server and stand-alone datalogger NETA-21 module enables worldwide and secure access to drives.

Ordering code	Description	Type designation
3AXD50000032449	PC cable, USB to RJ45	BCBL-01
3AXD50000019865	Cold configurator adapter, packed kit	CCA-01
3AUA0000094517	2 x panel bus interface 2 x 32 = max. 64 drives 2 x Ethernet interface SD memory card USB port for WLAN/3G	NETA-21

Flexible connectivity to automation networks

Fieldbus communication reduces wiring costs when compared with traditional hard wired input/output connections.

The ACS380 configured variant is compatible with a wide range of fieldbus protocols. Fieldbus modules come as preinstalled and proconfigured thus reducing commissioning time and allowing drive commissioning from the PLC. The ACS380

standard variant comes with built-in Modbus RTU protocol.

Support tools for integration with automation
Support for the fieldbuses is not always enough alone to get the full functionality and to make the integration easy. Due to this ABB also offers tools for seamless integration to automation systems of various manufacturers.

Universal communication with ABB fieldbus adapters

The machinery drives support the following fieldbus protocols:

Option code	Fieldbus protocol	Adapter
+K454	PROFIBUS DP, DPV0/DPV1	FPBA-01
+K457	CANopen®	FCAN-01
+K469	EtherCAT®	FECA-01
+K475	Two port EtherNet/IP™, Modbus TCP, PROFINET IO	FENA-21
+K470	Ethernet POWERLINK	FEPL-02



Standard interface and extensions for ACS380 machinery drives

The ACS380 machinery drives offer two different standard interfaces: the standard variant (I/O and Modbus) and the configured variant with different interfaces. In addition, the drive has one option slot available that can be used for speed feedback, relay extensions or options which allow an external +24 V supply. For further information please see the ACS380 hardware and firmware manuals.

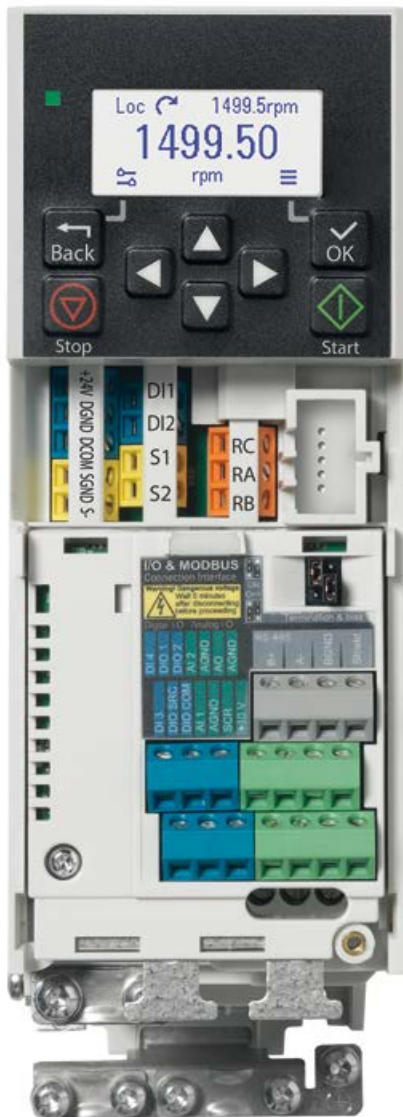

Default I/O connections of standard variant

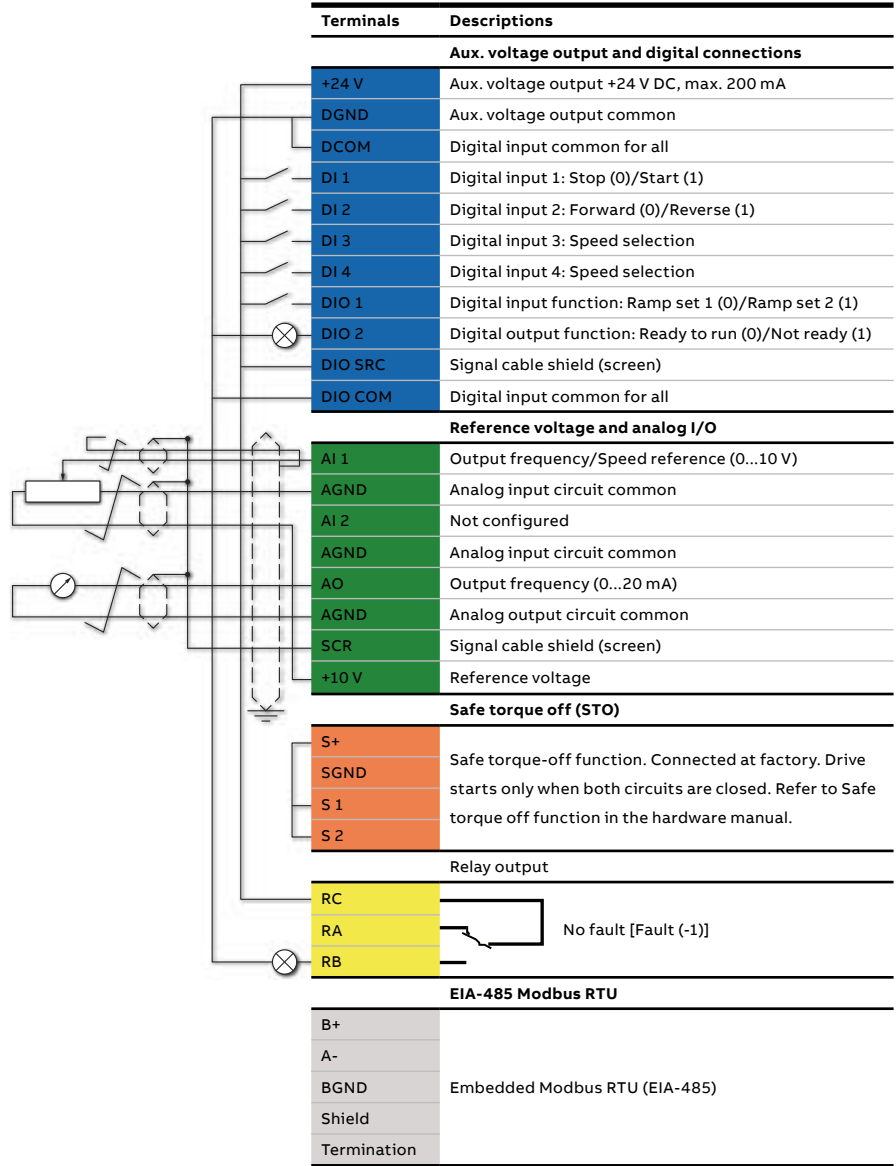

Default I/O connections of standard variant

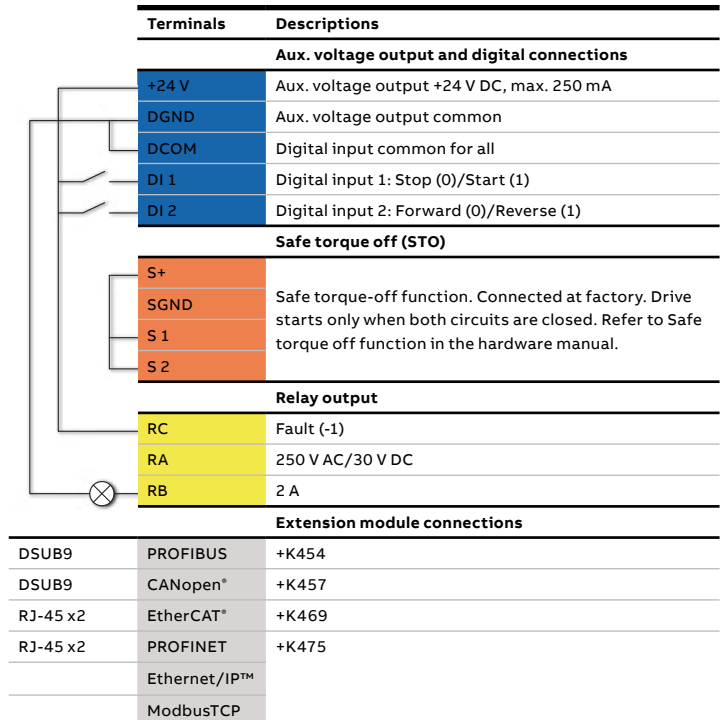

Input/output, extension and feedback modules for increased connectivity

Standard input and output of ACS380 machinery drives can be extended by using optional input/output extension modules. The modules are easily installed in the extension slots located in the drive. It is also possible to use an optional speed feedback module that supports TTL and HTL pulse encoders.



Extension module options

Option code	Description	Type designation
+L534	External 24 C DC	BAPO-01
+L511	External relay option (4xRO)	BREL-01
+L515	I/O extension	BIO-01

Feedback interface module options

Option code	Connections	Option
+L535	Encoder interface + External 24 V DC	BTAC-02

Brake options

Brake chopper

The brake chopper is built-in as standard for the ACS380. It not only controls braking, but also supervises system status and detects failures such as brake resistor and resistor cable short-circuits, chopper short-circuit, and calculated resistor over-temperature.

Control of the mechanical brake

Mechanical brake control is integrated into the ACS380 machinery drives. It uses state machine logic to control brake opening, closing, holding, wait and delay to integrate complex brake operation into the application.

Brake resistor

The brake resistors are separately available for the ACS380. Resistors other than the standard option resistors may be used, provided that the specified resistance value is within the specified limits and that the heat dissipation capacity of the resistor is sufficient for the drive application (see hardware manual). No separate fuses in the brake circuit are required if the conditions for e.g., the mains cable is protected with fuses and no mains cable/fuse overrating takes place.

1-phase $U_N = 200...240\text{ V}$ (200, 208, 220, 230, 240 V)

		Internal brake chopper			
	Frame	P_{BRcont} (kW)	R_{min} (ohm)	R_{max} (ohm)	P_{BRmax} (kW)
ACS380-04xx-02A4-1	R0	0.3	32.5	468.0	0.4
ACS380-04xx-03A7-1	R0	0.4	32.5	316.2	0.6
ACS380-04xx-04A8-1	R1	0.6	32.5	212.7	0.8
ACS380-04xx-06A9-1	R1	0.8	32.5	144.9	1.1
ACS380-04xx-07A8-1	R1	1.1	32.5	96.5	1.7
ACS380-04xx-09A8-1	R2	1.5	32.5	69.9	2.3
ACS380-04xx-12A2-1	R2	2.2	19.5	47.1	3.3

3-phase $U_N = 380...480\text{ V}$ (380, 400, 415, 440, 460, 480 V)

		Internal brake chopper			
	Frame	P_{BRcont} (kW)	R_{min} (ohm)	R_{max} (ohm)	P_{BRmax} (kW)
ACS380-04xx-01A8-4	R0	0.4	98.8	933.3	0.6
ACS380-04xx-02A6-4	R1	0.6	98.8	627.8	0.8
ACS380-04xx-03A3-4	R1	0.8	98.8	427.5	1.1
ACS380-04xx-04A0-4	R1	1.1	98.8	284.7	1.7
ACS380-04xx-05A6-4	R1	1.5	98.8	206.4	2.3
ACS380-04xx-07A2-4	R1	2.2	52.7	139.1	3.3
ACS380-04xx-09A4-4	R1	3.0	52.7	102.0	4.5
ACS380-04xx-12A6-4	R2	4.0	31.6	75.7	6.0
ACS380-04xx-17A0-4	R3	5.5	31.6	54.4	8.3
ACS380-04xx-25A0-4	R3	7.5	22.6	39.0	11.3
ACS380-04xx-032A-4	R4	11.0	5.6	29.3	16.5
ACS380-04xx-038A-4	R4	15.0	5.6	23.7	22.5
ACS380-04xx-045A-4	R4	18.5	5.6	19.7	27.8
ACS380-04xx-050A-4	R4	22.0	5.6	19.7	33.0

EMC – electromagnetic compatibility

The ACS380 machinery drives are equipped with a built-in filter to reduce high frequency emissions. Low EMC filters (C3 for 200 V and 400 V) are standard on ACS380-040X drives. High EMC filters (C2 for all voltages) are denoted by type codes ACS380-042X. C1 can be achieved with an external EMC filter.

EMC standards

The EMC product standard (EN 61800-3) covers the specific EMC requirements stated for drives (tested with motor and cable) within the EU. EMC standards such as EN 55011 or EN 61000-6-3/4 are applicable to industrial and domestic equipment and systems including components inside the drive. Drive units complying with the requirements of EN 61800-3 are compliant with

comparable categories in EN 55011 and EN 61000-6-3/4, but not necessarily vice versa. EN 55011 and EN 61000-6-3/4 do not specify cable length or require a motor to be connected as a load. The emission limits are comparable to EMC standards according to the table below.

Domestic environments versus public low voltage networks

The first environment includes domestic premises. It also includes establishments directly connected without an intermediate transformer to a low voltage power supply network that supplies buildings used for domestic purposes. The second environment includes all establishments directly connected to public low voltage power supply networks.

Comparison of EMC standards

EMC according to EN 61800-3 product standard	EN 61800-3 product standard	EN 55011, product family standard for industrial, scientific and medical (ISM) equipment	EN 61000-6-4, generic emission standard for industrial environments	EN 61000-6-3, generic emission standard for residential, commercial and light-industrial environment
1 st environment, unrestricted distribution	Category C1	Group 1, Class B	Not applicable	Applicable
1 st environment, restricted distribution	Category C2	Group 1, Class A	Applicable	Not applicable
2 nd environment, unrestricted distribution	Category C3	Group 2, Class A	Not applicable	Not applicable
2 nd environment, restricted distribution	Category C4	Not applicable	Not applicable	Not applicable

Input chokes and dU/dt filters

If there is need to optimize the line side harmonics,
an external input choke can be used together with ACS380.

1-phase $U_N = 200...240$ V (200, 208, 220, 230, 240 V)			
	C1 filter	Input choke, max. ambient temp. 40 °C	du/dt filter type, max. ambient temp. 40 °C
ACS380-04xx-02A4-1	TBA	ABB Drives: CHK-A1	ABB Drives: ACS-CHK-B3
ACS380-04xx-03A7-1	TBA	ABB Drives: CHK-B1	ABB Drives: ACS-CHK-B3
ACS380-04xx-04A8-1	TBA	ABB Drives: CHK-B1	ABB Drives: ACS-CHK-B3
ACS380-04xx-06A9-1	TBA	ABB Drives: CHK-C1	ABB Drives: ACS-CHK-C3
ACS380-04xx-07A8-1	TBA	ABB Drives: CHK-C1	ABB Drives: ACS-CHK-C3
ACS380-04xx-09A8-1	TBA	ABB Drives: CHK-D1	ABB Drives: ACS-CHK-C3
ACS380-04xx-12A2-1	TBA	ABB Drives: CHK-D1	ABB Drives: ACS-CHK-C3
3-phase $U_N = 380...480$ V (380, 400, 415, 440, 460, 480 V)			
	C1 filter	Input choke, max. ambient temp. 40 °C	du/dt filter type, max. ambient temp. 40 °C
ACS380-04xx-01A8-4	Schaffner FN 3268-7-44	ABB Drives: CHK-01	ABB Drives: ACS-CHK-B3
ACS380-04xx-02A6-4	Schaffner FN 3268-7-44	ABB Drives: CHK-01	ABB Drives: ACS-CHK-B3
ACS380-04xx-03A3-4	Schaffner FN 3268-7-44	ABB Drives: CHK-01	ABB Drives: ACS-CHK-B3
ACS380-04xx-04A0-4	Schaffner FN 3268-7-44	ABB Drives: CHK-02	ABB Drives: ACS-CHK-C3
ACS380-04xx-05A6-4	Schaffner FN 3268-7-44	ABB Drives: CHK-02	ABB Drives: ACS-CHK-C3
ACS380-04xx-07A2-4	Schaffner FN 3268-16-44	ABB Drives: CHK-02	ABB Drives: NOCH0016-6x
ACS380-04xx-09A4-4	Schaffner FN 3268-16-44	ABB Drives: CHK-03	ABB Drives: NOCH0016-6x
ACS380-04xx-12A6-4	Schaffner FN 3268-16-44	ABB Drives: CHK-03	ABB Drives: NOCH0016-6x
ACS380-04xx-17A0-4	Schaffner FN 3268-30-33	ABB Drives: CHK-04	ABB Drives: NOCH0030-6x
ACS380-04xx-25A0-4	Schaffner FN 3268-30-33	ABB Drives: CHK-04	ABB Drives: NOCH0030-6x
ACS380-04xx-032A-4	To be coming later	To be coming later	To be coming later
ACS380-04xx-038A-4	To be coming later	To be coming later	To be coming later
ACS380-04xx-045A-4	To be coming later	To be coming later	To be coming later
ACS380-04xx-050A-4	To be coming later	To be coming later	To be coming later

Cooling, fuses and circuit breakers

Cooling

ACS380 drives are fitted with variable-speed cooling air fans. The cooling air must be free from corrosive materials and not exceed the maximum ambient temperature of 50°C (60°C with derating*).

Fuse and circuit breakers

Standard fuses and circuit breakers can be used with ACS380. For input fuses or circuit breakers, see the table below. Also manual motor protectors can be used. See hardware manual for details.

Cooling air flow and recommended input protection fuses

1-phase $U_n = 200...240$ V (200, 208, 220, 230, 240 V)

		Heat dissipation*		Air flow		Max. noise level dBA	IEC fuses		IEC fuses		UL fuses	
		W	BTU/ Hr	m ³ /h	ft ³ / min		A	Fuse type	A	Fuse type	A	Fuse type
ACS380-04xx-02A4-1	R0	52	178	-*	-*	<30	10	gG	32	gR	10	UL class T
ACS380-04xx-03A7-1	R0	66	226	-*	-*	<30	10	gG	32	gR	10	UL class T
ACS380-04xx-04A8-1	R1	84	287	57	33	63	16	gG	40	gR	20	UL class T
ACS380-04xx-06A9-1	R1	109	373	57	33	63	20	gG	50	gR	20	UL class T
ACS380-04xx-07A8-1	R1	120	408	57	33	63	25	gG	63	gR	25	UL class T
ACS380-04xx-09A8-1	R2	140	477	63	37	59	32	gG	63	gR	25	UL class T
ACS380-04xx-12A2-1	R2	170	579	63	37	59	35	gG	63	gR	35	UL class T

Cooling air flow and recommended input protection fuses

3-phase $U_n = 380...480$ V (380, 400, 415, 440, 460, 480 V)

		Heat dissipation		Air flow		Max. noise level dBA	IEC fuses		IEC fuses		UL fuses	
		W	BTU/ Hr	m ³ /h	ft ³ / min		A	Fuse type	A	Fuse type	A	Fuse type
ACS380-04xx-01A8-4	R0	46	156	-*	-*	<30	4	gG	25	gR	6	UL class T
ACS380-04xx-02A6-4	R1	60	205	57	33	63	6	gG	25	gR	6	UL class T
ACS380-04xx-03A3-4	R1	67	229	57	33	63	6	gG	25	gR	6	UL class T
ACS380-04xx-04A0-4	R1	75	256	57	33	63	10	gG	32	gR	10	UL class T
ACS380-04xx-05A6-4	R1	93	317	57	33	63	10	gG	32	gR	10	UL class T
ACS380-04xx-07A2-4	R1	112	383	57	33	63	16	gG	40	gR	20	UL class T
ACS380-04xx-09A4-4	R1	139	476	57	33	63	16	gG	40	gR	20	UL class T
ACS380-04xx-12A6-4	R2	183	624	63	37	59	25	gG	50	gR	25	UL class T
ACS380-04xx-17A0-4	R3	232	793	128	75	66	32	gG	63	gR	35	UL class T
ACS380-04xx-25A0-4	R3	346	1182	128	75	66	50	gG	80	gR	50	UL class T
ACS380-04xx-032A-4	R4	460	1570	216	127	69	63	gG	100	gR	60	UL class T
ACS380-04xx-038A-4	R4	561	1916	216	127	69	80	gG	125	gR	80	UL class T
ACS380-04xx-045A-4	R4	663	2263	216	127	69	100	gG	160	gR	100	UL class T
ACS380-04xx-050A-4	R4	663	2263	216	127	69	100	gG	160	gR	100	UL class T

*Frame size R0 with free convection cooling

Below listed miniature circuit breakers are tested and approved to be used with ACS380. Other circuit breakers can also be used with the drive if they provide the same electrical characteristics.

Circuit breakers			
1-phase $U_N = 200...240$ V (200, 208, 220, 230, 240 V)	Frame	ABB miniature circuit breaker	kA¹⁾
		Type	
ACS380-04xx-02A4-1	R0	S 201P-B 10 NA	5
ACS380-04xx-03A7-1	R0	S 201P-B 10 NA	5
ACS380-04xx-04A8-1	R1	S 201P-B 16 NA	5
ACS380-04xx-06A9-1	R1	S 201P-B 20 NA	5
ACS380-04xx-07A8-1	R1	S 201P-B 25 NA	5
ACS380-04xx-09A8-1	R2	S 201P-B 25 NA	5
ACS380-04xx-12A2-1	R2	S 201P-B 32 NA	5
3-phase $U_N = 380...480$ V (380, 400, 415, 440, 460, 480 V)			
ACS380-04xx-01A8-4	R0	S 203P-B 4	5
ACS380-04xx-02A6-4	R1	S 203P-B 6	5
ACS380-04xx-03A3-4	R1	S 203P-B 6	5
ACS380-04xx-04A0-4	R1	S 203P-B 8	5
ACS380-04xx-05A6-4	R1	S 203P-B 10	5
ACS380-04xx-07A2-4	R1	S 203P-B 16	5
ACS380-04xx-09A4-4	R1	S 203P-B 16	5
ACS380-04xx-12A6-4	R2	S 203P-B 25	5
ACS380-04xx-17A0-4	R3	S 203P-B 32	5
ACS380-04xx-25A0-4	R3	S 203P-B 50	5
ACS380-04xx-032A-4	R4	Contact ABB	
ACS380-04xx-038A-4	R4	Contact ABB	
ACS380-04xx-045A-4	R4	Contact ABB	
ACS380-04xx-050A-4	R4	Contact ABB	

¹⁾ Maximum allowed rated conditional short-circuit current (IEC 61800-5-1) of the electrical power network.

Need a motor? This is our offering.

Our machinery drives control virtually any type of AC motor including induction, permanent magnet, servo and synchronous reluctance motors. Our adaptable machinery drives ensure an energy efficient and reliable motor controller with significant cost savings for the user.

Machinery drives and induction motors form a reliable combination

Induction motors are used throughout the industry in several types of industry applications which demand robust and high enclosure motor and drive solutions. The ACS380 machinery drives fit perfectly together with this type of motor, used in a wide range of industrial environments.

Machinery drives and permanent magnet motors for smooth operation

Permanent magnet technology is often used for improved motor characteristics such as energy efficiency, compactness and control

performance. Actual characteristics between different permanent magnet motors can vary considerably. Machinery drives can control ABB's and most other permanent magnet motors in an efficient way.

Machinery drives and IE4 synchronous reluctance motors for a package with high efficiency

Combining the machinery drives control technology with our synchronous reluctance (SynRM) motors provides an IE4 motor and drive package that gives you great energy savings benefits. The key is in the rotor design. The synchronous reluctance rotor replaces the traditional induction rotor and requires no permanent magnets. ABB has tested the SynRM motor and drive packages and produced manufacturer's statements providing verified system (drive and motor efficiency).



Save time, ease troubleshooting and improve drive performance with ABB smartphone apps

Better connectivity and user experience with Drivetune

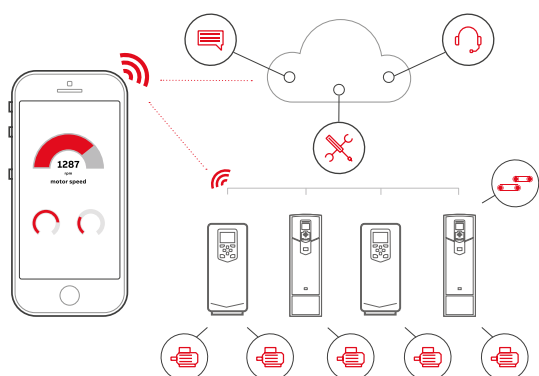

Easy and fast access to product information and support

Manage your drives and the process lines and machines they control



Easy access to cloud-based drive and process information from anywhere via an online connection



Start up, commission and tune your drive and application



Simplified user guidance with instant access to drive status and configuration



Performance optimization via drive troubleshooting features and fast support

Services and support on the go with Drivebase

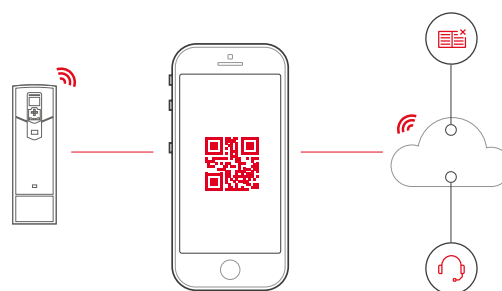

Search for support documents and contacts

Maintain and service all your installed drives on one or multiple sites



Get 6 months extra warranty for free by registering your drive with the Drivebase app



Access your product and service information in the cloud from anywhere



Access your drive's diagnostics data



Push notifications for critical product and service updates

Access information anywhere

Download the apps using the QR codes below or directly from the app stores



Drivetune for commissioning and managing drives



Drivebase for ensured reliability and reduced downtime on production sites

Services to match your needs

Your service needs depend on your operation, life cycle of your equipment and business priorities. We have identified our customers' four most common needs and defined service options to satisfy them. What is your choice to keep your drives at peak performance?

Is uptime your priority?

Keep your drives running with precisely planned and executed maintenance.

Example services include:

- ABB Ability Life Cycle Assessment
- Installation and Commissioning
- Spare Parts
- Preventive Maintenance
- Reconditioning
- ABB Drive Care agreement
- Drive Exchange

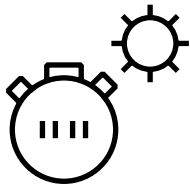

Operational efficiency

Is rapid response a key consideration?

If your drives require immediate action, our global network is at your service.

Example services include:

- Technical Support
- On-site Repair
- ABB Ability Remote Assistance
- Response time agreements
- Training

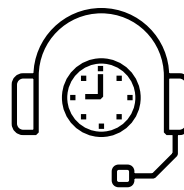

Rapid response

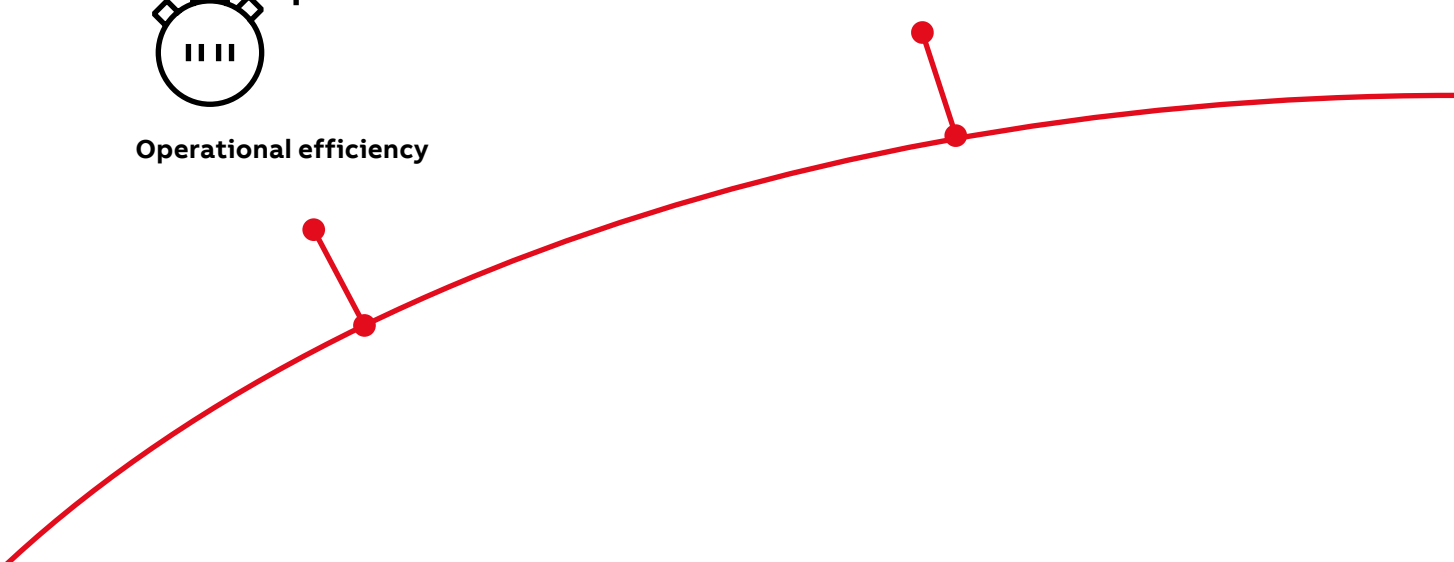

Drives service

Your choice, your future

The future of your drives depends on the service you choose.

Whatever you choose, it should be a well-informed decision. No guesswork. We have the expertise and experience to help you find and implement the right service for your drive equipment. You can start by asking yourself these two critical questions:

- Why should my drive be serviced?
- What would my optimal service options be?

From here, you have our guidance and full support along the course you take, throughout the entire lifetime of your drives.

Need to extend your assets' lifetime?

Maximize your drive's lifetime with our services.

Example services include:

- ABB Ability Life Cycle Assessment
- Upgrades, Retrofits and Modernization
- Replacement, Disposal and Recycling

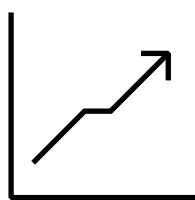

Life cycle management

Your choice, your business efficiency

ABB Drive Care agreement lets you focus on your core business. A selection of predefined service options matching your needs provides optimal, more reliable performance, extended drive lifetime and improved cost control. So you can reduce the risk of unplanned downtime and find it easier to budget for maintenance.

We can help you more by knowing where you are!

Register your drive at www.abb.com/drivereg for extended warranty options and other benefits.

Is performance most critical to your operation?

Get optimal performance out of your machinery and systems.

Example services include:

- ABB Ability Remote Services
- Engineering and Consulting
- Inspection and Diagnostics
- Upgrades, Retrofits and Modernization
- Workshop Repair
- Tailored services

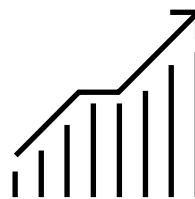

Performance improvement

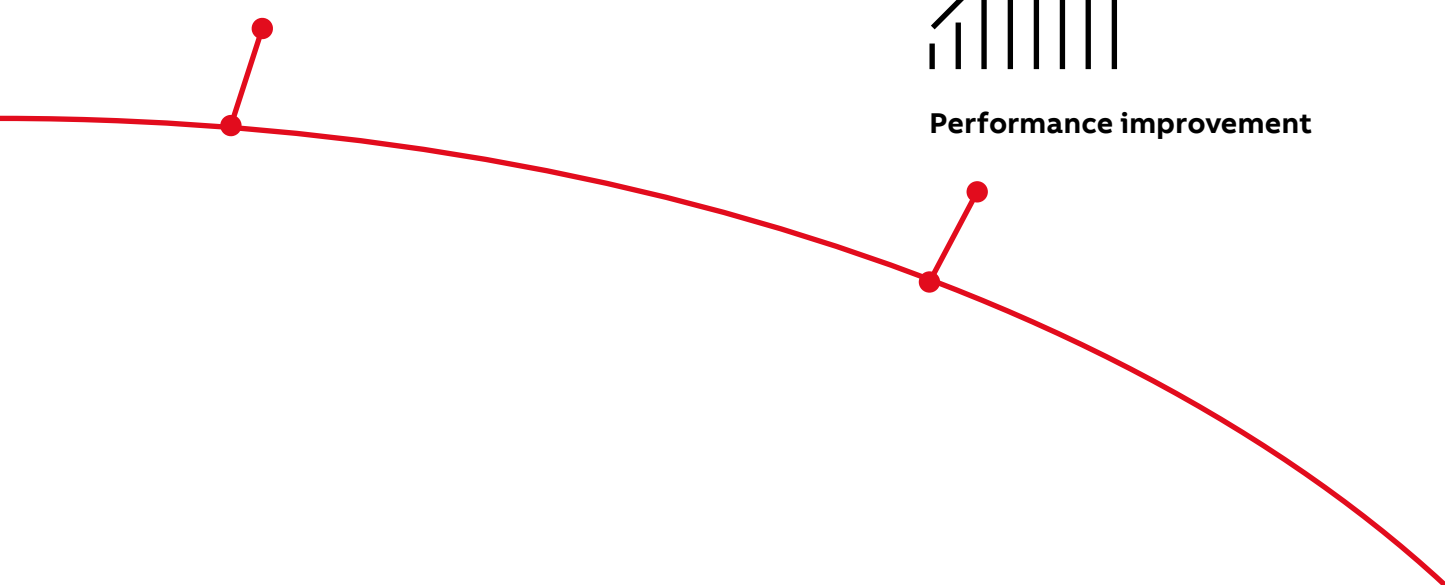

—
For more information, please contact
your local ABB representative or visit

www.abb.com/drives
www.abb.com/drivespartners
www.abb.com/motors&generators

Online manuals
for the ACS380 drives



Video playlist:
ACS380 how-to videos

